

CLV 490 Bar Code Scanner with autofocus

Advanced Line

Real-time AUTOFOCUS.

The CLV 490 from SICK

The CLV 490 ensures maximum, tilt-independent read rates with minimum code height. The real-time AUTOFOCUS function provides optimum read rates at maximum depths of field (DOF), since the device is always focused in accordance with the distance of the bar code.



Line scanner

Maximum power in a compact design:

- Real-time AUTOFOCUS function
- High density, standard density, low density
- Label tilt from $-45^\circ \dots +45^\circ$
- Reliable code recognition using SMART technology
- Smallest unit in its class
- Additional interface for external parameter memory
- Flash PROM for firmware
- Available as line scanner or line scanner with oscillating mirror
- Optional heater

THE CLV 490 ADVANTAGES AT A GLANCE

- Enhanced reading performance compared with existing SICK bar-code scanners of the same size
- No additional components required to detect the object distance
- Extremely high depth of field even for smallest module widths thanks to the real-time AUTOFOCUS function
- External memory (connector) means that parameters do not have to be redefined each time the scanner is changed

With SMART Code Recognition Technology



Line scanner with oscillating mirror

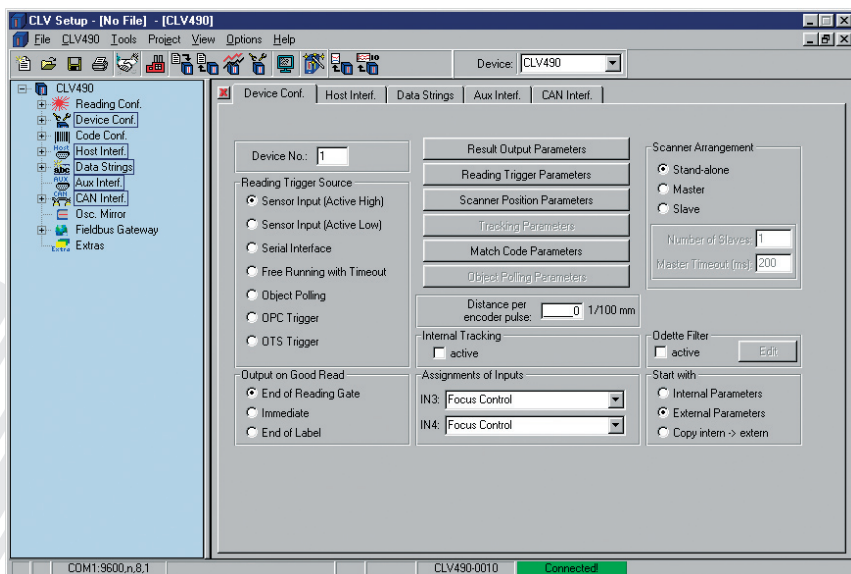

Easy to operate and configure with the CLV Setup program

- OMNI applications
- Applications with large object distances/depth of field (DOF)
- Grid box/pallet applications
- Object identification in boxes
- Tasks in parcel and courier services

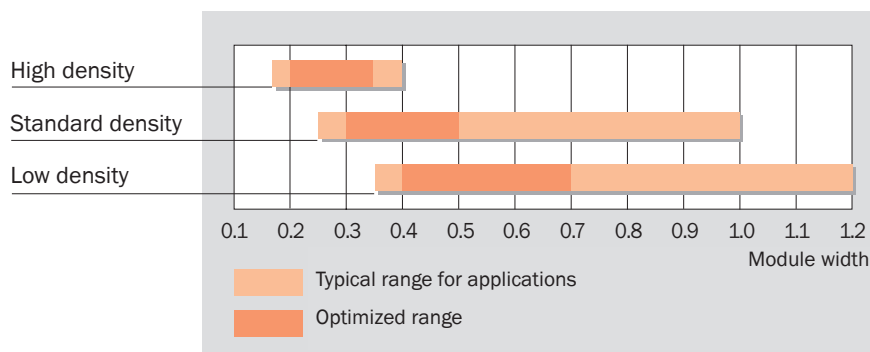
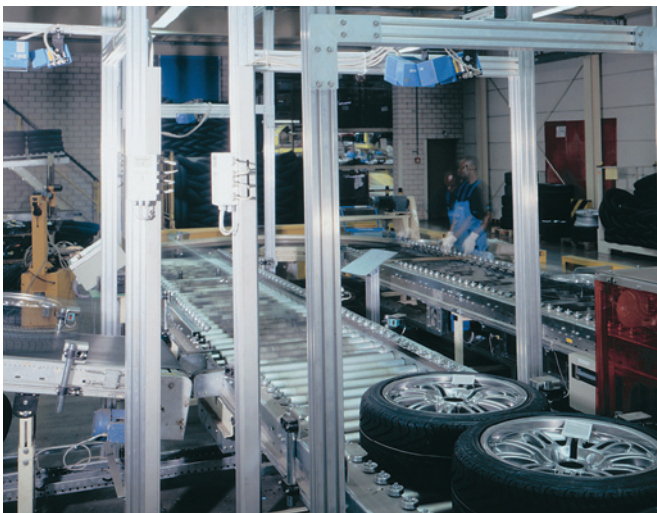

Application ranges for the variants as a function of module width

Line scanner. (standard density)

Reading field height
[mm]

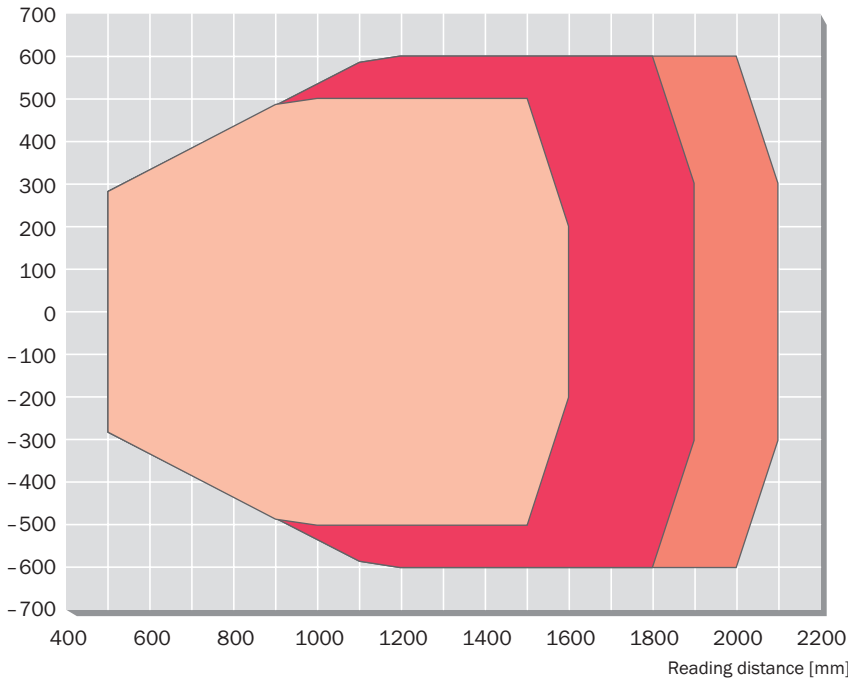

Resolution:

- 0.30 mm
- 0.35 mm
- 0.50 mm

Reading conditions:

Test code: code 128

Print contrast: > 90 %

Ambient light: < 2000 lx

Tilt: - 45° ... + 45°

Pitch: - 15° ... + 15°

Skew: - 15° ... + 15°

Reading field diagram CLV 490 line scanner: standard density

Line scanner with oscillating mirror. (standard density)

Reading field height
[mm]

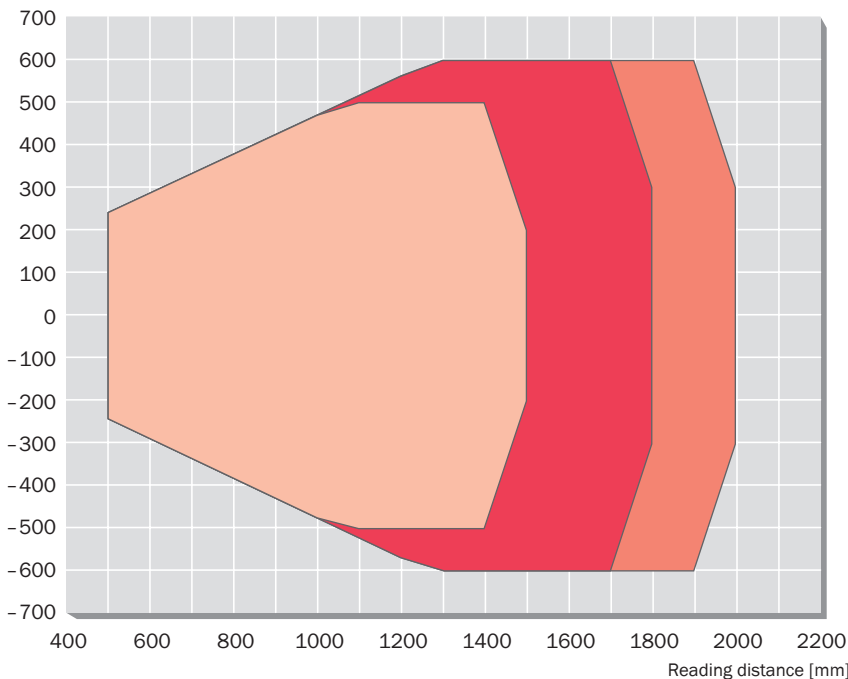

Resolution:

- 0.30 mm
- 0.35 mm
- 0.50 mm

Reading conditions:

Test code: code 128

Print contrast: > 90 %

Ambient light: < 2000 lx

Tilt: - 45° ... + 45°

Pitch: - 15° ... + 15°

Skew: - 15° ... + 15°

Reading field diagram CLV 490 line scanner with oscillating mirror: standard density

Line scanner. (high density)

Reading field height
[mm]

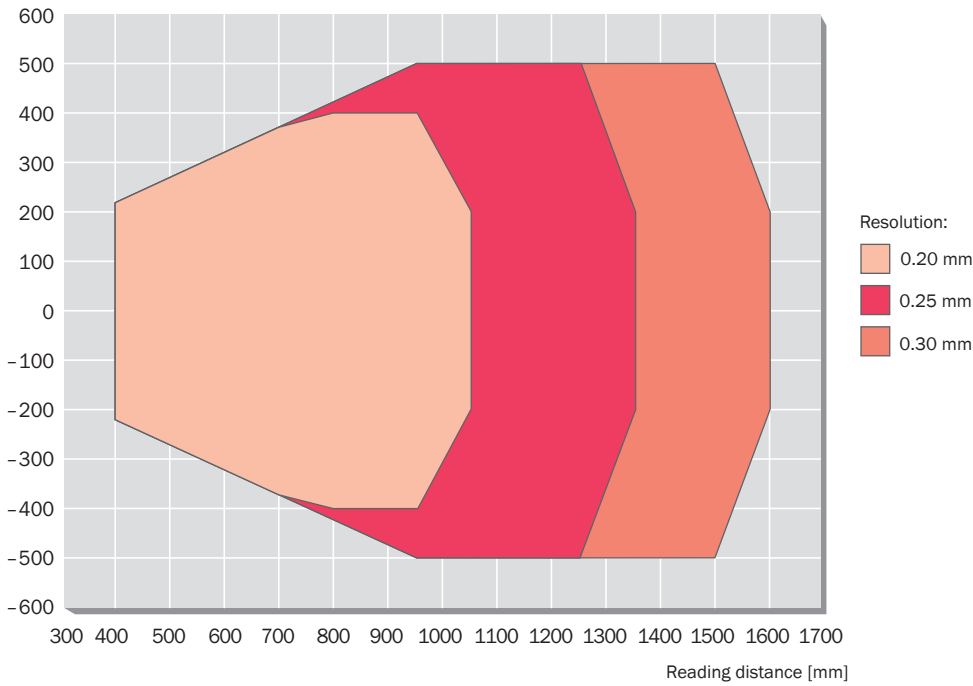

Reading conditions:
 Test code: code 128
 Print contrast: > 90 %
 Ambient light: < 2000 lx

Tilt: - 45° ... + 45°
 Pitch: - 15° ... + 15°
 Skew: - 15° ... + 15°

Reading field diagram CLV 490 line scanner: high density

Line scanner. (low density)

Reading field height
[mm]

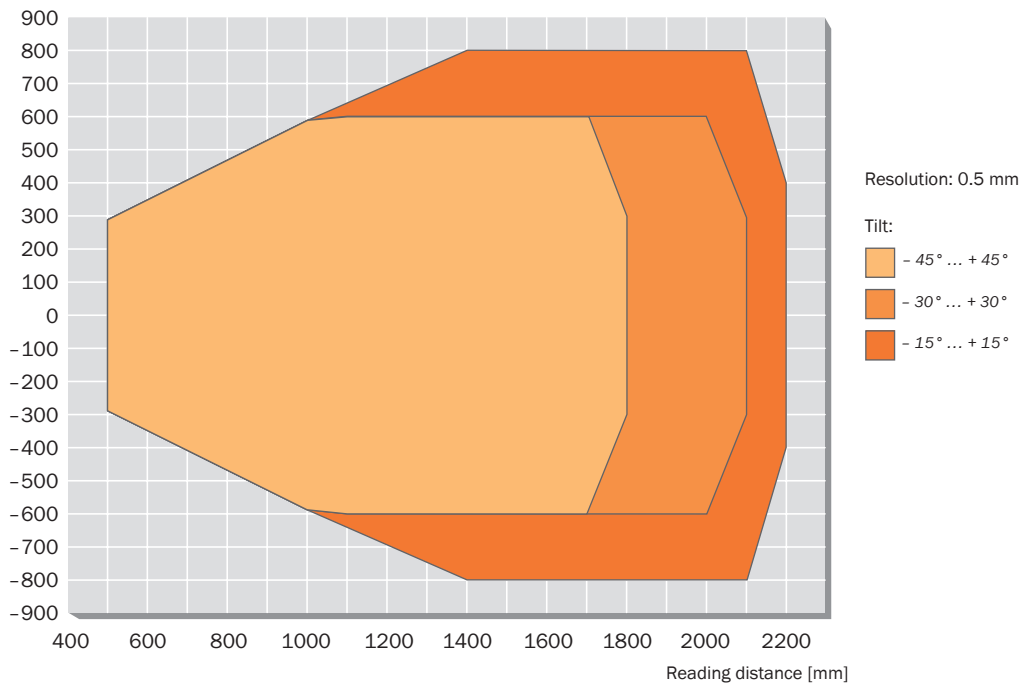

Reading conditions:
 Test code: code 128
 Print contrast: > 90 %
 Ambient light: < 2000 lx

Pitch: - 15° ... + 15°
 Skew: - 15° ... + 15°

Reading field diagram CLV 490 line scanner: low density

Line scanner.

Line scanner with oscillating mirror. (standard density)

Reading distance as a function of the scanning frequency for line scanner

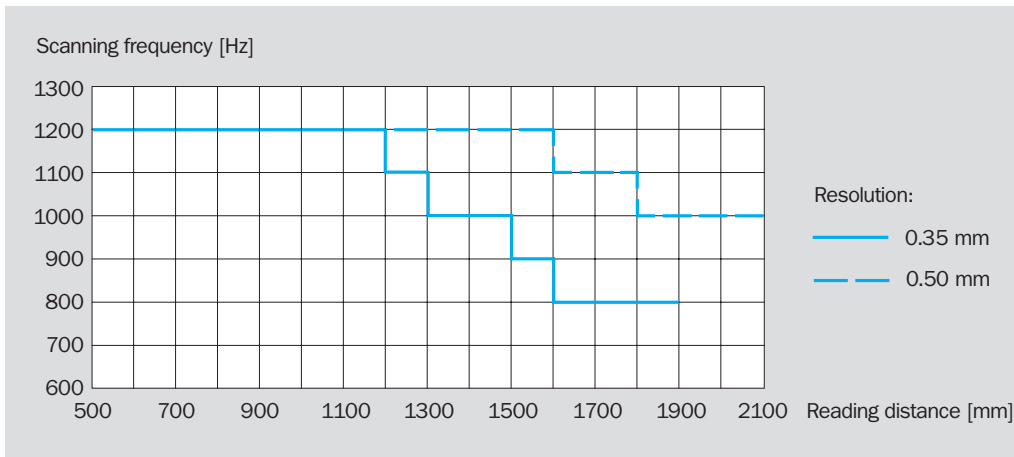

CLV 490 Bar-Code Scanner

Design	Line scanner, options: with oscillating mirror, heating
Resolution	Standard density, high density, low density
Light source	Laser diode, red light ($\lambda = 650 \text{ nm}$)
Laser class	2 (to EN 60825-1)
Ambient light compability	2000 lx (on bar code)
Scanning/decoding frequency	600 ... 1200 Hz
Aperture angle	Max. 60° (max. 50° with oscillating mirror)
Operation and parametrization	With Windows-based CLV-Setup software or command strings
Indicators	4 LED (status indicators)
Data interface	Host: RS 232, RS 422/485; terminal: RS 232
Switching inputs/outputs	6 x IN / 4 x OUT
Operating voltage	18 ... 30 V DC (24 V DC + 20 % / - 10 % with heating)
Power consumption	Line scanner: typical 11 W, max. 16 W typical 75 W, max. 90 W (with heating) Line scanner with oscillating mirror: typical 13 W, max. 18 W typical 75 W, max. 100 W (with heating)
Electrical connections	2 x 15-pin D Sub-HD plug/socket
Housing	Die-cast aluminium
Enclosure rating	IP 65 (to DIN 40 050)
Protection class	Class 3 (to VDE 0106)
EMC test	To EN 61000-6-2, EN 61000-6-3
Weight	1.5 kg (line scanner)/2.2 kg (with oscillating mirror)
Temperature (ambient operating/storage)	0 ... +40 °C (-35 ... +35 °C with heating)/-20 ... +70 °C

All dimensions in mm

Drilled hole,
 $\varnothing 3.6$; 6 mm deep

Trapped blind hole
M 6, 7 mm deep

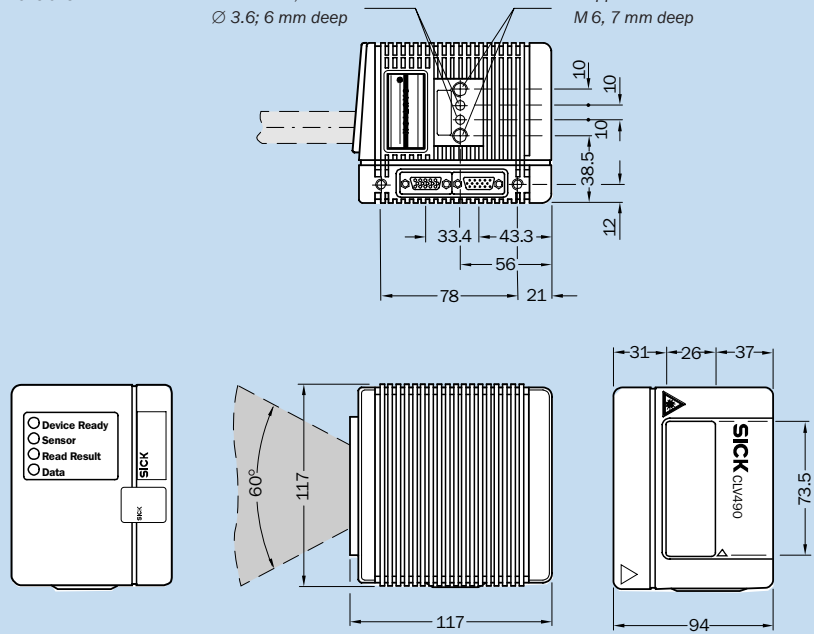

Dimensional drawing
CLV 490 line scanner

All dimensions in mm

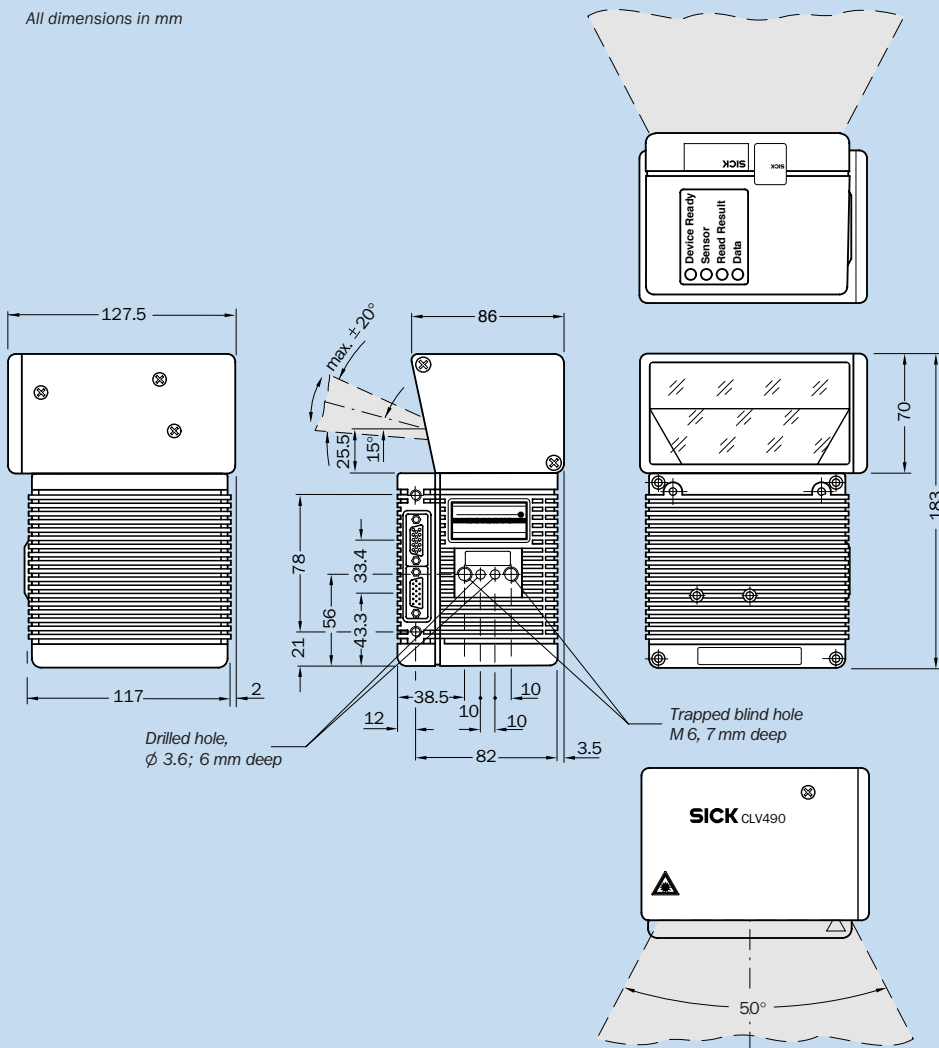

Dimensional drawing CLV 490
line scanner with oscillating mirror

RANGE OF EXPERTISE

INDUSTRIAL SENSORS

Our complete range of sensors provides answers to suit any application in the field of automation. Even under rugged ambient conditions objects are reliably detected, counted and positioned in respect of their form, location and surface finish, as well as their distances established with pin-point accuracy.

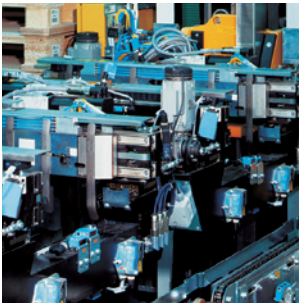

INDUSTRIAL SAFETY SYSTEMS

Comprehensive safeguarding of both personnel and machinery! As specialists in Sensor Technology, SICK develops and manufactures pioneering products for providing protection in hazardous zones, dangerous locations and for safeguarding access points. By providing services, which encompass all aspects of machine safety and security, SICK is setting new standards in Safety Technology.



AUTO IDENT

Whether the tasks involve identification, handling, classification or volume measurement, innovative Auto Ident systems and laser measuring systems function extremely reliably, even under rapid cycle times. They conform to the latest Standards and can be simply and speedily integrated in all industrial environments and external applications.



ANALYZERS AND PROCESS INSTRUMENTATION

System control, maintaining setpoints, optimising process control and monitoring the flow of materials – the instruments and services for Analysis and Process Measurement, supplied by SICK MAIHAK, are setting the standards for these applications in terms of Technology and Quality.



Worldwide present with subsidiaries in the following countries:

Australia
Belgium/Luxembourg
Brasil
Česká Republika
China
Danmark
Deutschland
España
France
Great Britain
India
Italia
Japan
Nederlands
Norge
Österreich
Polska
Russia
Schweiz

Singapore
Republic of Korea
Republika Slovenija
Suomi
Sverige
Taiwan
Türkiye
USA/Canada/México

Please find the detailed addresses and more representatives and agencies in all major industrial nations at www.sick.com